

**Zoneworks, HIVE (HV/HVG) and DATA Monitored Options**

Fittings with part numbers -ZW, -HV, -HVG -DATA are fitted with Zoneworks communications modules (nodes). These fittings are monitored using either Powerline Carrier Technology that utilize the power cable to provide data communication, RF transceiver modules operating in the ISM band or a dedicated data cable to/from data routers installed on a dedicated data trunk connected to a central Server (can also be connected via Ethernet/Internet/Fibre). Zoneworks software on the server is used to monitor, coordinate testing and collate test data from each fitting. Zoneworks Fittings can be commissioned by a single push of the test switch or by scanning the supplied barcode. The LED Test Switch indicator provides a multifunction indication of the status of the fitting during testing and normal operation:

Option	State	LED Operation
ZW, HV, HVG DATA	Commissioned	LED on Solid (Green)
ZW, DATA	Un-commissioned	<b>Batt plugged-in:</b> yellow 1s, green 1s
		<b>Batt unplugged:</b> red 1s, off 1s
HV/HVG	Un-commissioned With network connectivity	<b>Batt plugged-in:</b> yellow 1s, green 1s
		<b>Batt unplugged:</b> red 1s, off 1s
HVHVG	Un-commissioned Without network connectivity	<b>Batt plugged-in:</b> yellow 250mS, green 250mS, yellow 250mS, green 250mS, green 1s
		<b>Batt unplugged:</b> red 250mS, off 250mS, red 250mS, off 250mS, off 1s
ZW, DATA	Emergency Light Test In Progress	LED flashes at yellow 5s , Off 1s
HV/HVG	Emergency Light Test In Progress	LED flashes at yellow 1s , Off 1s

In the case of the DATA version a 2-way “figure 8” cable and terminal block facilitates the connection to the DATA network via a multi-drop bus (daisy chain connection). For further information of installation of a Zoneworks system, please refer to the Zoneworks Users Guide and Commissioning Guide (incl. DATA version)

**DALI EM Option**

Luminaires with part numbers having -DALI are fitted with DALI modules (nodes) that facilitate connection and integration to 3<sup>rd</sup> Party Lighting Control Systems. Before installing the -DALI luminaire, please confirm that the Lighting Control System has the capability to monitor DALI Emergency Luminaires. The -DALI fitting will be addressed and configured into the control system by the Lighting Control System Commissioning Technicians and not Clevertronics.

State	LED Operation
Commissioned/ Un-commissioned	LED on Solid (Green)
Emergency Light Test in progress	LED flashes at 1s On (Yellow) & 1s Off
“IDENTIFY COMMAND”	Lamp and Status LED Flash for 30 seconds

A 2-way “figure 8” cable and terminal block facilitates the connection to the DALI network. DALI connections are marked as Da Da.

**Caution:**

On many building sites, power circuits may be cut off in an uncontrolled and repetitive basis during construction. As a result, any Exit & Emergency Units, on these circuits, will have their batteries discharged or “cycled”. The battery in this fitting has been selected to give excellent long-life performance in a controlled AS2293 testing environment. Excessive battery cycling will reduce through-life performance and may lead to premature battery failure. Battery warranty claims, as a result of such abuse, are specifically EXCLUDED from Clevertronics warranty terms.

**Rated Emergency Lumen Output in accordance with AS2293.1 (refer to spacing tables for installation positions):**

Refer to the Technical Label for classification information.



**ARGO Weatherproof Emergency LED Batten  
Switchable Colour & Output  
Installation & Maintenance Instruction Leaflet**

**Victoria (Head Office & Manufacturing)**

Website: [www.clevertronics.com.au](http://www.clevertronics.com.au)

Email: [info@clevertronics.com.au](mailto:info@clevertronics.com.au)

Phone: +61 3 9559 2700

Fax: +61 3 9559 2799

**New South Wales**

Phone: +61 2 8805 6400

Fax: +61 2 8805 6444

**Queensland**

Phone: +61 7 3442 9700

Fax: +61 7 3442 9777

**South Australia/Northern Territory**

Phone: +61 8 8301 8800

Fax: +61 8 8351 8286

**Western Australia**

Phone: +61 8 9207 0000

Fax: +61 8 9207 0088

**New Zealand**

Phone: +64 800 548 448

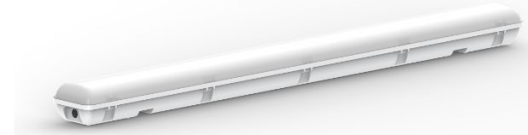

3000K 4000K 5700K

**Designed in Australia to comply with the requirements of AS2293.3: 2018, AS CISPR15: 2017**

**Models: ARGO-1200-xxx-LP-yy-zz**

**Testing:**

Manual Test yy = Blank Zoneworks yy = ZW Microwave Sensor (HI/LO) xxx = SEN

DALI Registered yy = DALI Zoneworks HIVE yy = HV/HVG Fused Terminal Block zz = FTB



**Spare Parts:**

1550230 Replacement Battery  
8002681 Replacement 240V LED Strip  
AUM02370050001 Replacement Emergency Driver  
1330083 Replacement 240V Driver  
1330082 Replacement 240V Driver (for -SEN)

**Important:**

It is illegal for anyone, except for a licensed electrician to install or maintain this product. Before installation, ensure that the electricity supply has been switched off and isolated. Installation must be carried out in accordance with the relevant Australian and International Standards.

Note: This luminaire (with reinforced insulation between control/LED terminal and AC Supply) contains non-user replaceable light source and battery – to be replaced (if required, refer installation instructions for battery replacement) by the manufacturer or his service agent or a similar qualified person.

## Installation:

The product can be mounted to or suspended from any solid surface. Please follow the below installation steps:

- Determine the installation method (surface/surface with clips) and the power entry method.
- Undo the diffuser clips, remove the diffuser and gear tray. Position the batten base in the desired location. Mark out the fixing points on the mounting surface.
- If the cable entry is to be via the rear of the body – Drill out a suitable entry-hole in the rear of the batten body (must be suitably sealed after cable entry using a sealant). If the cable entry is via the end of the batten - Install the provided cable gland, or bring in conduit, to the base as required for the intended power access. Note: Only round cables are to be used with the cable gland for an IP65 seal. Keep cable entry straight and tension free. Ensure all seals are tight. min. wire diameter 6mm, max. 12mm.
- **For surface mounting -**, there are 2 extrusions/posts at each end of the base. Drill out the desired number of fixing points at each end. **Fixings must only be through the extrusions/mounting posts.**
  - Position the fitting to the mounting surface and mark the mounting holes.
  - Drill the mounting holes.
  - Fix the base to the surface with appropriate fixings.
  - Seal mounting area with appropriate sealant.
- **For Surface Mount Clip mounting**, measure/mark spacing (see dimensions below), install stainless steel clips to surface (use appropriate fixings), then snap batten into clips.
- Re-attach battery into Emergency Driver & remove Warning Label from Terminal Block.
- Wire mains power cable, 240V 50Hz, to terminals marked Lsw (Switched Active), Lem (Emergency/Unswitched Active), N &  $\oplus$
- Set LED Driver Power Output to either Low (2000Lm) or High(4000Lm) (non-MS-HL version only)
- Set Colour Switch to the desired colour (3000K, 4000K, 5700K)
- Attach gear tray to lanyards.
- Reinstall the gear tray, diffuser and latch the diffuser clips.

## Wiring:

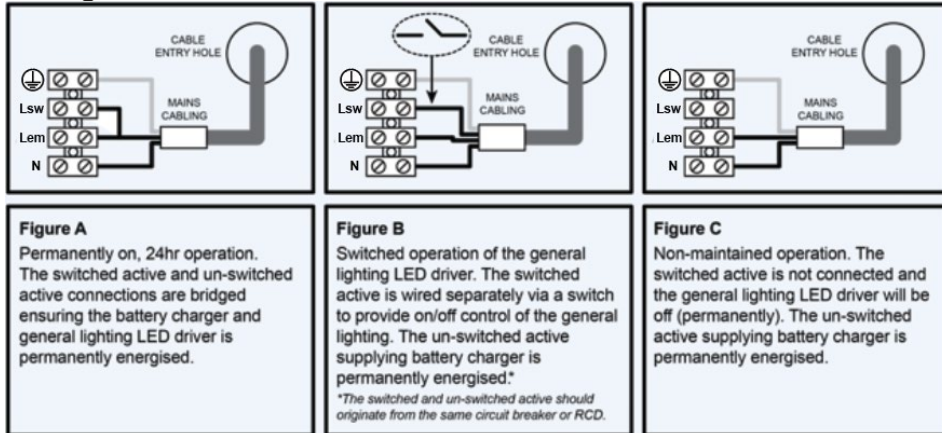

## Sensor Version:

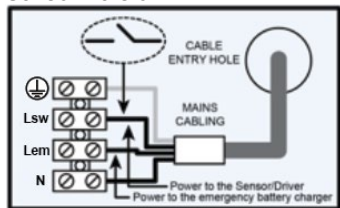

## Dimensions:

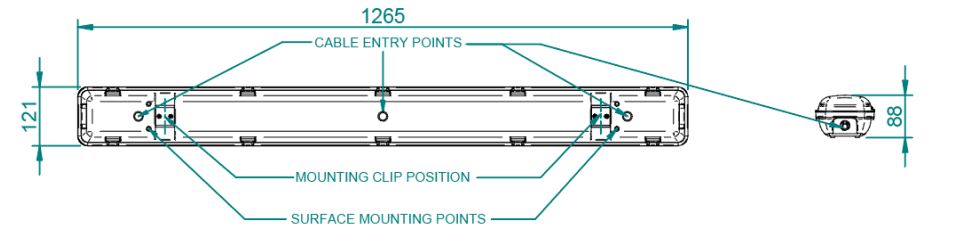

### Driver Setting:

(non-SEN version only)

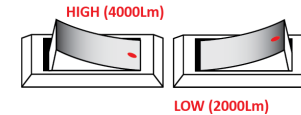

### Colour Setting:

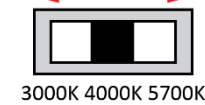

### Gear Tray Clip:

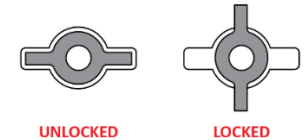

## Battery Replacement:

1. Prior to any work, isolate power to any Batten that requires battery replacement
2. Open the Diffuser by releasing the Diffuser Clips (remove any screws that may have been installed)
3. Unlock the Gear Tray by rotating the Gear Tray Clips 90° in an anti-clockwise direction (ensure the Gear Tray is supported while unlocking clips)
4. Remove Battery connector from the Emergency Driver
5. Remove Battery and Battery Clips from the Gear Tray (release one side of clips to remove battery and clips together as one)
6. Install replacement Battery & Clips and connect into Emergency Driver
7. Re-Install the Gear Tray and ensure Clips are locked (rotate clips by 90° clockwise)
8. Re-Install the Diffuser and close all clips (re-install any screws that may have been inserted into the Diffuser Clips)

## Testing:

Once connected to the 240V mains supply, the unit must be allowed to charge the battery for at least 24 hours. Conduct the following tests:

- For the first test, the emergency lamp must remain illuminated for at least 2 hours after disconnection from the mains supply.
- Subsequent tests require the unit to illuminate for at least 90 minutes. The results of all tests are required to be recorded in a service logbook, which is to be kept on-site at all times. If the unit fails to remain illuminated for the requisite time, remedial action must be taken to repair the situation and once completed, the unit must pass a subsequent test. For more specific information, please refer to the current edition of the AS 2293.3 Standard.
- Press and hold Test Button or switch Off Mains Supply, check that the emergency lamp is On.
- Release the Test Button or Switch On Mains Supply, check that the emergency lamp is Off (Non-maintained operation).

## Trouble Shooting:

Below are a list of common problems and their possible causes.

**Fault:** The Green LED Test Switch indicator is not illuminated.

Check: A.C. is connected and is turned on.  
Battery is connected  
Test Switch for damage.

**Fault:** Lamp does not illuminate in emergency mode.

Check: A.C. is connected.  
Lamp is correctly inserted.  
Battery is connected

**Fault:** Lamp illuminates in emergency mode, but only stays on for a short period.

Check: Battery has been allowed to charge for at least 24 hours.  
Battery for damage.

## Warranty:

For Product Warranty information and Terms and Conditions of Sales please refer to our website <http://clevertronics.com.au/terms-conditions-sale-australia-nz/>